



Water Underfloor Heating Kit

- ✓ For small & large rooms
- ✓ 50 year pipe warranty
- ✓ CE approved
- ✓ Easy to install

INSTALLATION MANUAL



UNDERFLOOR HEATING SYSTEM

SINGLE ROOM SYSTEM INSTALLATION MANUAL



Manufactured in
Europe!



Thank you for investing in our industry leading ProWarm™ underfloor heating system

ProWarm™ Water Underfloor Heating Systems are the ideal choice for homeowners and tradesmen wishing to install a premium branded water underfloor heating kit.

This instruction manual contains important information regarding the safe installation and operation of your underfloor heating system. Please read carefully.

See our online videos for helpful guidance

In addition to this manual we have online installation videos that guide you through each stage of process with easy to follow CGI graphics and helpful dialogue. [Scan QR code to watch video >](#)



Before you begin Installing:

Please read through these instructions carefully and check that you have all the components required. ProWarm™ water underfloor heating kits contain everything you need in one box for your water underfloor heating project. NB: This single zone system is controlled by one thermostat.

- ✓ A rated UPS 2 Grundfos pump
- ✓ PE-Xb-multilayer pipe to suit area
- ✓ Edging insulation (NA: for low profile)
- ✓ Manual Thermostat
- ✓ Pipe Staples (if required)
- ✓ Pipe Cutters
- ✓ Pipe rerounding tool
- ✓ All pipe connections to fix pipe to pump and manifold*



*Larger room kits will include suitable manifold & pump



We use **high quality multi layered pipe** (PE-Xb-AI-HDPE) in all our ProWarm™ water underfloor heating systems

AN INNER LAYER in cross-linked polyethylene PE-Xb (crosslinked with silanes)

AN INTERMEDIATE LAYER in aluminium alloy, butt-welded along length of pipe.

50 YEAR PIPE WARRANTY

- ✓ PE-Xb-AI-HDPE.
- ✓ Working pressure & temperature 10bar, 95°C.
- ✓ 100% oxygen impermeable.
- ✓ Lifetime warranty.

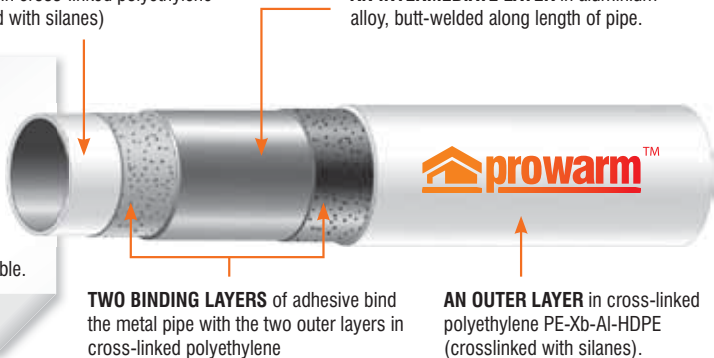

TWO BINDING LAYERS of adhesive bind the metal pipe with the two outer layers in cross-linked polyethylene

AN OUTER LAYER in cross-linked polyethylene PE-Xb-AI-HDPE (crosslinked with silanes).

Installation for a **small room** (single circuit system)

- 1) Select a suitable location for the pump/control valve unit and mount on the wall.
- 2) Fit the two nut & inserts as in the pump / control valve assembly shown on opposite page.
- 3) Refer to the typical pipe installation drawings and determine the pipe layout - the layout is not critical and can be varied to suit site conditions, the important criteria being the pipe spacing, see below.
- 4) The pipe is marked every metre by the metre. (maximum length for any circuit is 110m, 70m for low profile 12mm pipe circuit).
- 5) Pipes should be laid 100mm away from walls.
- 6) Do not lay pipe under fixed units.
- 7) Lay the pipe as planned, fixing every 1.0m if on a screeded celotex base and return to the manifold.
- 8) If the pipe is kinked when bending, the pipe should be straightened and rearranged so that the location of the kink remains in a straight length, no other remedial action is required.
- 9) To connect the circuit, cut the pipe end squarely using the plastic pipe cutter, re-round the pipe end with the tool provided, place the nut over the pipe, ensure the olive and insert is fully fitted over the end of the pipe and the assembly is attached to the pump. Tighten the nut using an open end spanner. Do not over tighten.
- 10) Prevent people from walking on the pipes, keep tools etc away from the pipes and use running boards. The pipe is very tough, but it is better to be safe than sorry.
- 11) It is **IMPORTANT** that the underfloor heating system is properly filled with water (use a garden hose) and purged completely of air to ensure correct operation, .
- 12) **IT IS NOT ADEQUATE TO FILL THE SYSTEM USING THE BOILER FILLING LOOP!**

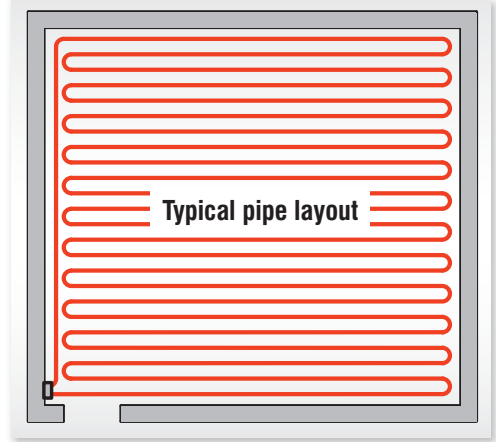

PIPE SPACINGS

STANDARD OUTPUT SYSTEM suitable for internal well insulated areas such as a living room, kitchen or bathroom. **Pipe spacings are set at 250mm centres.**

HIGH OUTPUT SYSTEM suitable for areas of high heat loss, ideal for conservatories, extensions and external buildings. **Pipe spacings are set at 200mm centres.**

LOW PROFILE SYSTEM panels are spaced at 150mm centres

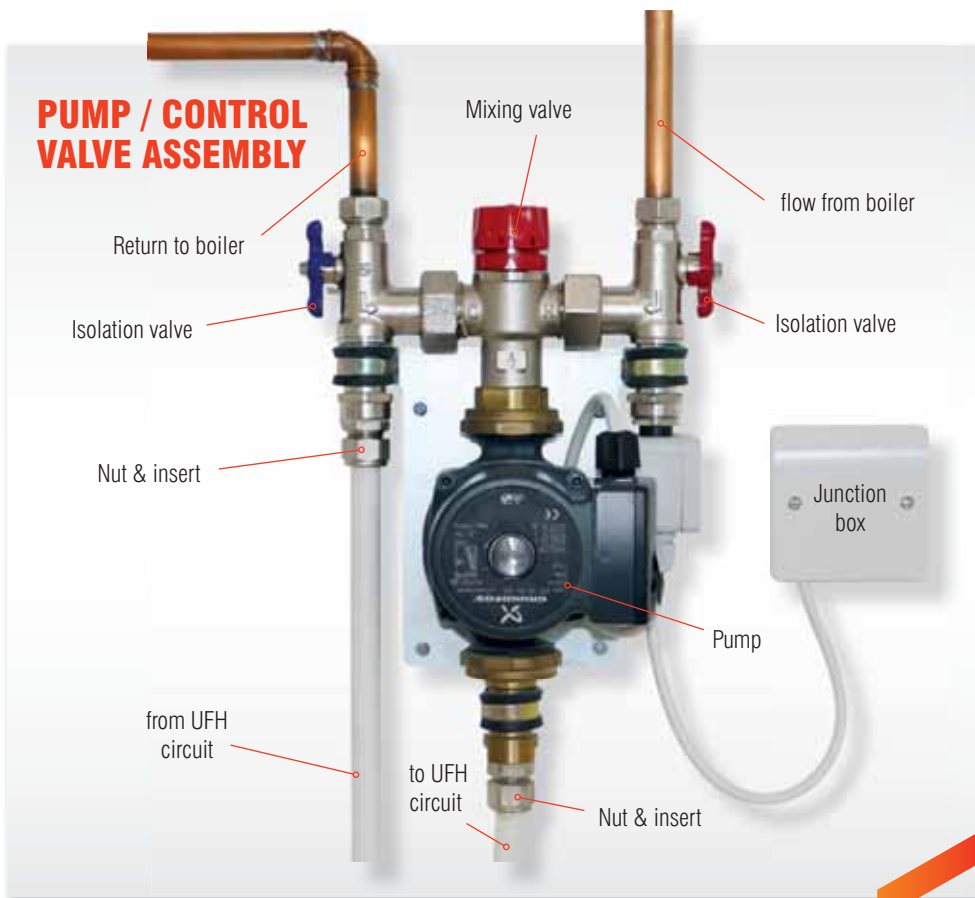

COMMISSIONING

- 1) Screed or chipboard flooring should be laid immediately after pipelaying to protect the pipe.
- 2) Concrete screed floors must be cured before any heat is applied, a general rule of thumb is to allow 1 day per 2 millimetres of screed (check with screed installer).
- 3) Timber floor with drymix infill can have heat applied immediately, the drymix must be dried completely before laying the flooring.
- 4) Hardwood timber flooring must be 'conditioned' before fixing.
- 5) It is important to purge the pipework from the boiler to the manifold, to avoid air being introduced into the underfloor heating system.
- 6) Initially start the system with the thermostatic valve set at min (35°C).
- 7) Increase the setting by 5° per day, up to a maximum of 50° for concrete floors, max 60° for timber floors.
- 8) NOTE. When first starting up the system it may take 12-24 hours for the heating effect to become apparent!

Installation for a **large room** (multi circuit system)

- 1) Select a suitable location for the pump & manifold unit and mount on the wall.
See opposite page for assembly.
- 2) Refer to the typical pipe installation drawings and determine the pipe layout - the layout is not critical and can be varied to suit site conditions, the important criteria being the pipe spacing, see below.
- 3) The pipe is marked every metre by the metre.
(maximum length for any circuit is 110m, 70m for low profile 12mm pipe circuit).
- 4) Pipes should be laid 100mm away from walls.
- 5) Do not lay pipe under fixed units.
- 6) To lay the circuit, cut the pipe end squarely using the plastic pipe cutter, re-round the pipe end with the tool provided, place the nut over the pipe, ensure the olive and insert is fully fitted over the end of the pipe and the assembly is attached to the manifold. Tighten the nut using an open end spanner. Do not over tighten.
- 7) Lay the pipe as planned, fixing every 1.0m if on a screeded celotex base and return to the manifold.
- 8) If the pipe is kinked when bending, the pipe should be straightened and rearranged so that the location of the kink remains in a straight length, no other remedial action is required.
- 9) Prevent people from walking on the pipes, keep tools etc away from the pipes and use running boards. The pipe is very tough, but it is better to be safe than sorry.

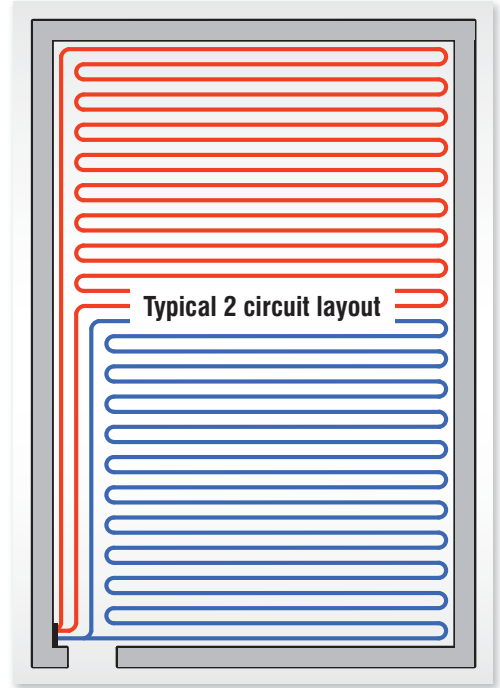

PIPE SPACINGS

STANDARD OUTPUT SYSTEM suitable for internal well insulated areas such as a living room, kitchen or bathroom. **Pipe spacings are set at 250mm centres.**

HIGH OUTPUT SYSTEM suitable for areas of high heat loss, ideal for conservatories, extensions and external buildings. **Pipe spacings are set at 200mm centres.**

LOW PROFILE SYSTEM panels are spaced at 150mm centres

PUMP & MANIFOLD ASSEMBLY

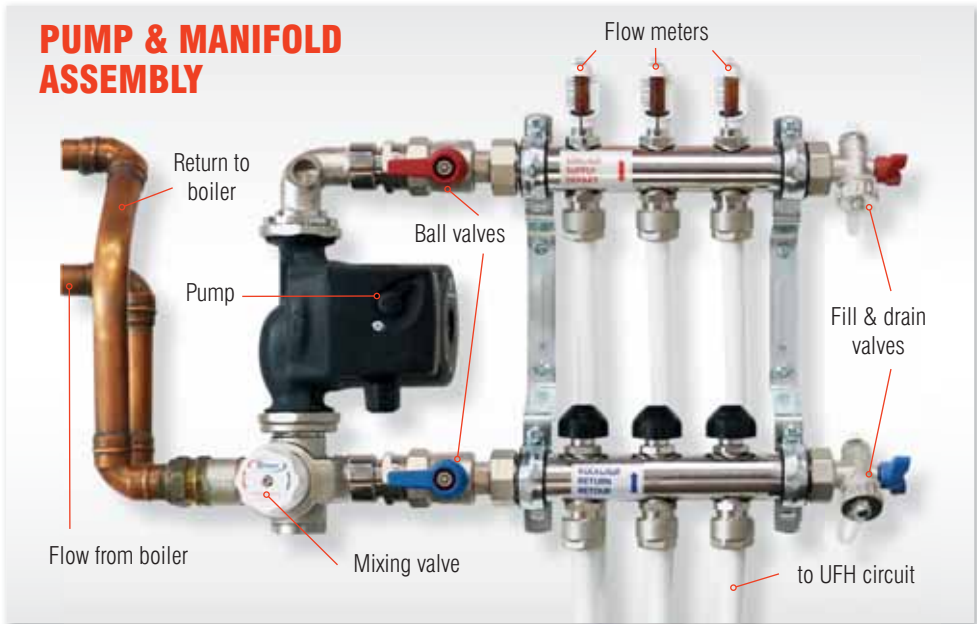

FILLING THE MANIFOLD SYSTEM

- 1) It is **IMPORTANT** that the underfloor heating system is properly filled with water and purged completely of air to ensure correct operation, it is therefore necessary to follow the procedure below.
- 2) **IT IS NOT ADEQUATE TO FILL THE SYSTEM USING THE BOILER FILLING LOOP!**
- 3) Connect a hose from a mains pressure cold water supply to the hose connection on the top (flow) manifold, and another hose from the hose connection on the bottom (return) manifold to a drain.
- 4) Ensure that all the black caps on the bottom (return) manifold are screwed down, closing the valves.
- 5) Ensure that the main flow & return ball valves are closed on the manifold.
- 6) Turn on the water and open the hose connection valve on the top (flow) manifold.
- 7) Open the first circuit valve by unscrewing the black cap allowing water to flow into the pipe.
- 8) Open the hose connection valve on the bottom (return manifold) allowing water to flow freely into the drain until the water is clear with no air bubbles.
- 9) Open the second circuit valve (black cap) and close the first.
- 10) Open the third circuit valve and close the second etc.

FILLING THE MANIFOLD SYSTEM (cont.)

- 11) Continue until the last circuit has been purged and close the hose connection valve on the bottom (return) manifold before closing the last circuit valve (black cap).
- 12) While under pressure, check manifold & pipework for leakage.
- 13) Close hose connection valve on the top (flow manifold) and remove the hoses.
- 14) If possible pressure test the system to 6 bar for 2 hours.

COMMISIONING

- 1) Screed or chipboard flooring should be laid immediately after pipelaying to protect the pipe.
- 2) Concrete screed floors must be cured before any heat is applied, a general rule of thumb is to allow 1 day per 2 millimetres of screed.
- 3) Timber floor with drymix infill can have heat applied immediately, the drymix must be dried completely before laying the flooring.
- 4) Hardwood timber flooring must be 'conditioned' before fixing.
- 5) It is important to purge the pipework from the boiler to the manifold, to avoid air being introduced into the underfloor heating system.
- 6) It is not normally necessary to balance the system but if required follow this procedure. The system is balanced by running the pump, and adjusting the flow to each zone by turning the square spigots under the blue caps on the bottom manifold, the flow in the respective sight glasses should be set at a figure calculated by dividing the length of pipe for that zone by 40. Example: Circuit 1, $85\text{m}/40 = \text{approx } 2$ on the scale. Low profile systems circuit at $70\text{m} \div 40 = 1.75$.
- 7) Initially start the system with the thermostatic valve set at min (35°C).
- 8) Increase the setting by 5° per day, up to a maximum of 50° for concrete floors, max 65° for timber floors.
- 9) The flow & return from the boiler should be connected to the manifold connections shown using compression couplings.
- 10) NOTE. When first starting up the system it may take 12-24 hours for the heating effect to become apparent!

Electrical setup for single & multi circuit systems

- 1) Wiring to the thermostat will be dependant on the type of thermostat chosen.
- 2) Thermostat position in the room is not critical but positions affected by the sun should be avoided, mounting height approx 1.5m.
- 3) The room thermostat is used to switch the pump.
- 4) The single circuit pump control valve unit incorporates a pipe thermostat and will not operate unless hot water is available from the boiler/heating system.

Schematic for system boiler & UFH + radiators + hot water

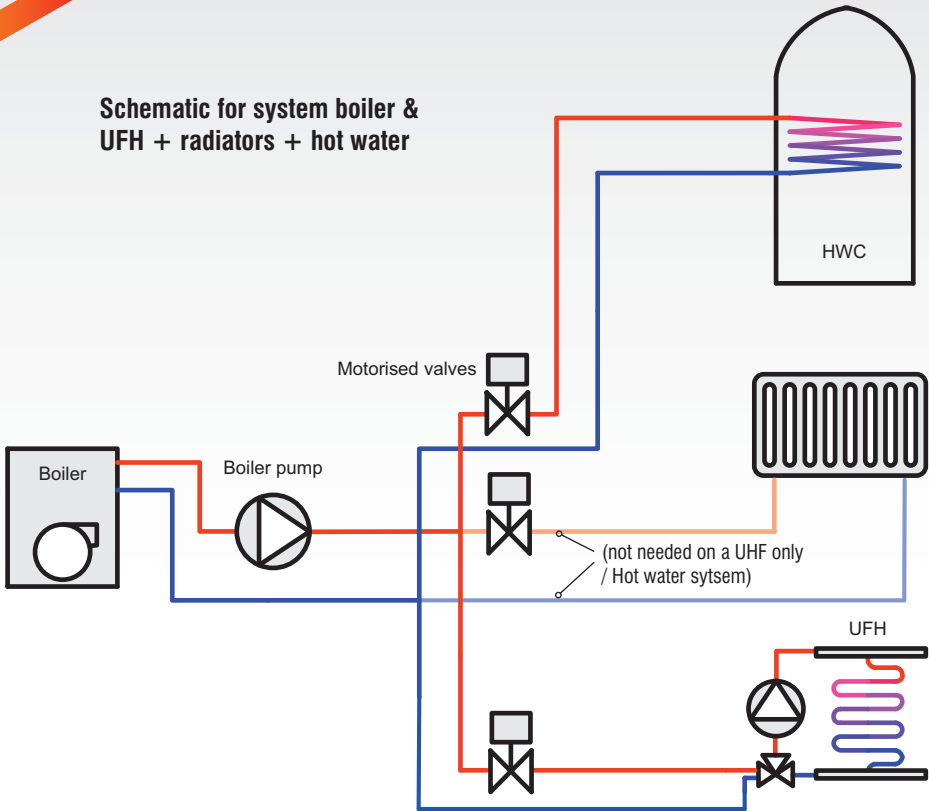

Schematic for gas combination boiler & underfloor heating + radiators

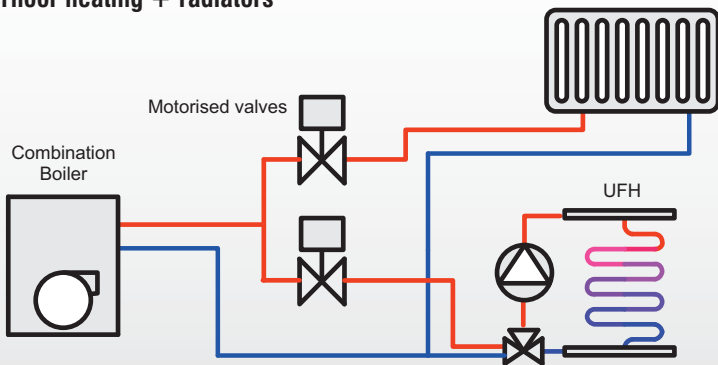

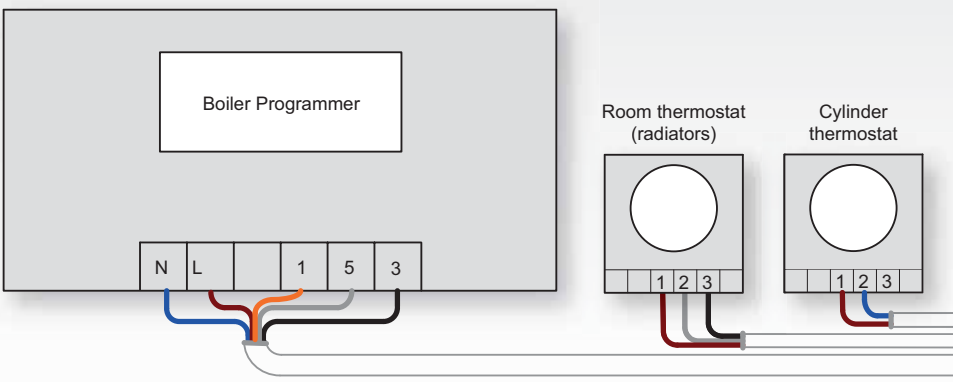

(Earth wires omitted for clarity)

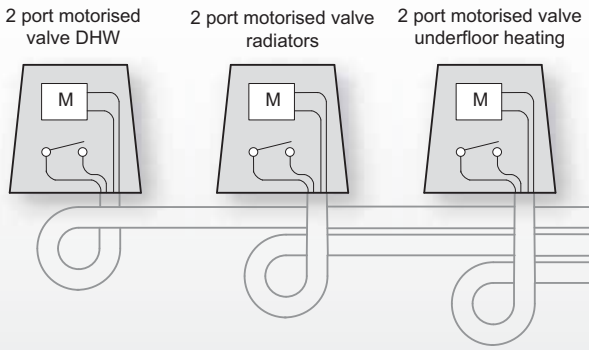
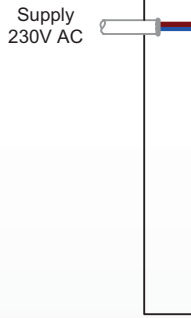

Typical electrical connection

single circuit ufh + existing 's' plan system + system boiler

Set up for dial thermostat. For thermostat upgrade wiring options / diagrams, please see our website for details

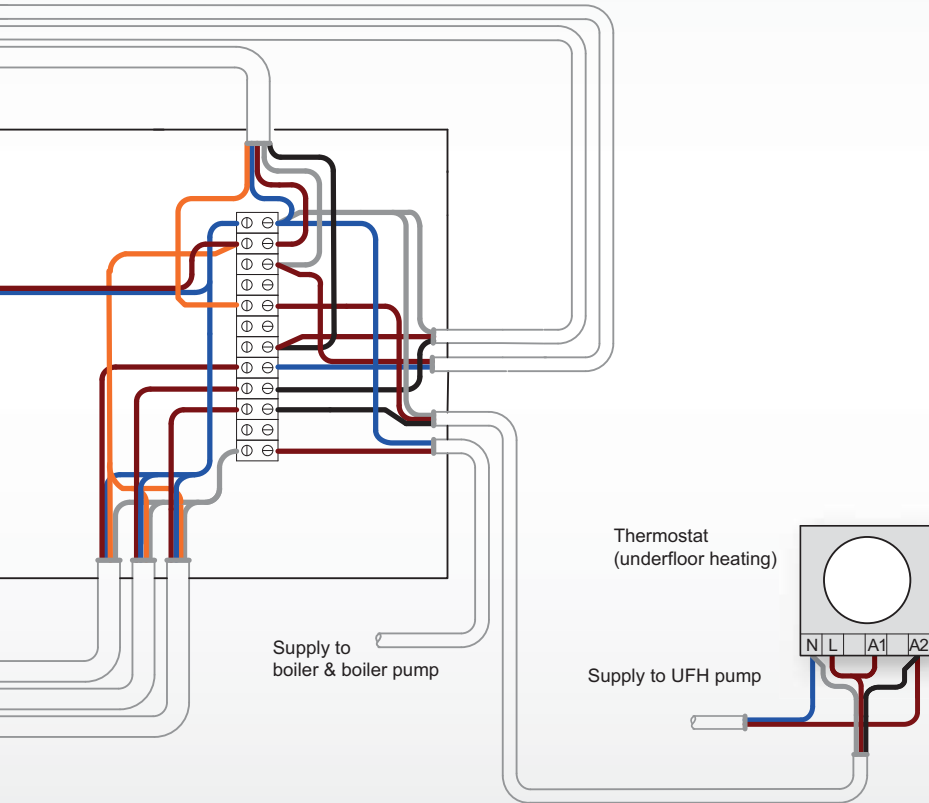

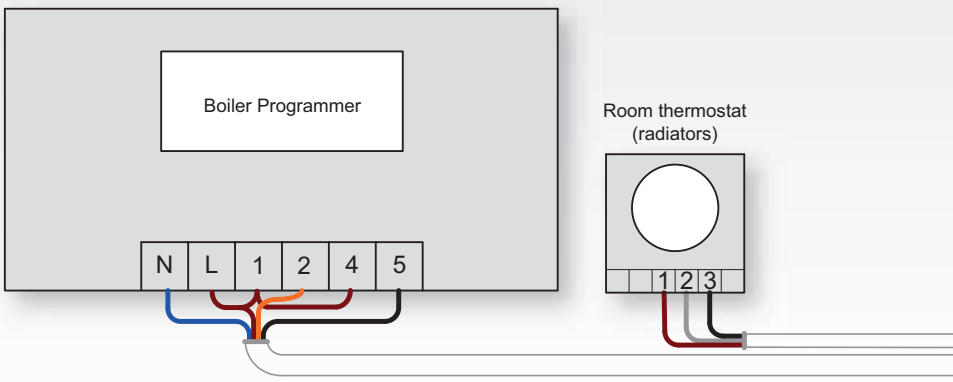

(Earth wires omitted for clarity)

Supply
230V AC

2 port motorised valve
radiators

2 port motorised valve
underfloor heating

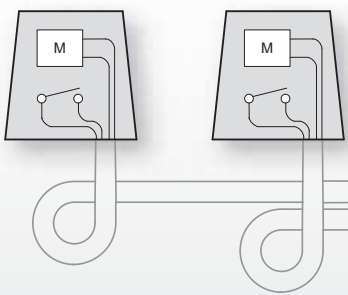

Typical electrical connection

Single circuit ufh + radiators + combination boiler

Set up for dial thermostat. For thermostat upgrade wiring options / diagrams, please see our website for details

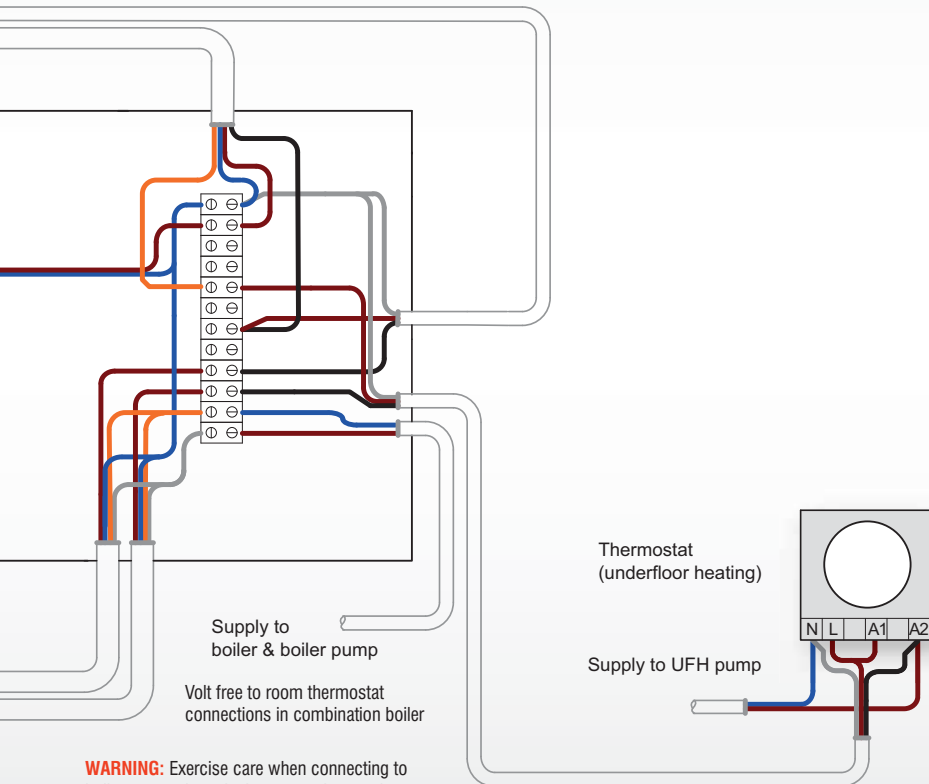

WARNING: Exercise care when connecting to boiler connections, its important that a voltage is not applied to boiler terminals from this control system or damage to boiler may occur.

Typical fixing methods

UNDER NEW CONCRETE OR SCREED FLOORS

A cost effective solution for installing water underfloor heating into new build properties or new extensions.

This type of system installation is the most popular and cost effective type on the market today, the pipes are incased in screed or concrete meaning that the whole floor warms up like one huge storage radiator. This system is normally for new build houses or extensions/conservatories.

CLIP RAIL SYSTEM



BETWEEN JOISTS OR SUSPENDED FLOORS

Installing water underfloor heating between joists is easy using our different installation solutions.

Please note all in joist systems require the pipe spacing to be 200mm apart or less
This means you need to select a conservatory style kit or a multiple room kit – standard room kits are designed with the pipe spacing at 250mm centers which would mean you would not have enough pipe in the kit

SPREADER PLATE SYSTEM



OVER EXISTING FLOORS

Installing water underfloor heating over existing floors is simple using our different installation solutions.

Our overfloor systems can be installed directly over any solid subfloor such as existing floorboards, plywood or concrete/ screed floors, or any solid surface such as existing tiles/ wooden floors.

FLOATING FLOOR PANELS for finished timber floor

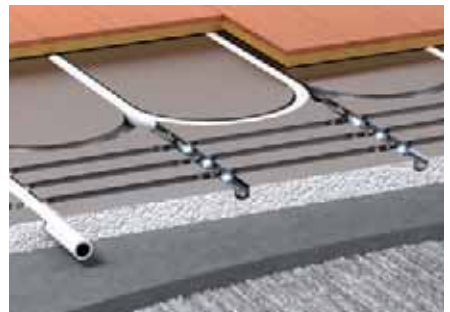

PLASTIC EGG CRATE SYSTEM



CLIPPED DIRECT WITH STAPLES

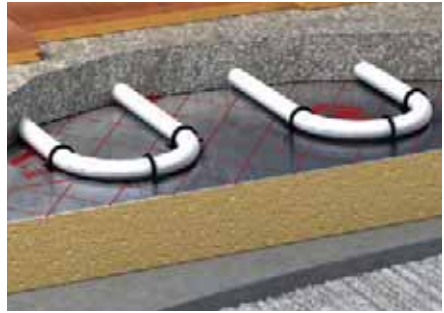

DRY BISCUIT MIX/ SCREED SYSTEM

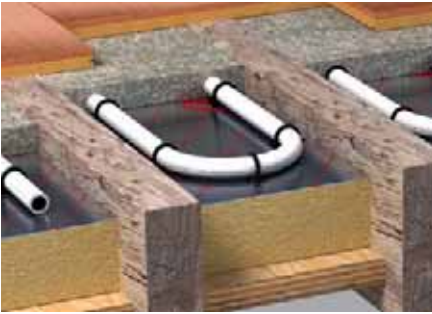

IN JOIST FOIL BOARDS



SOLID FLOOR PANELS for finished tiled floor

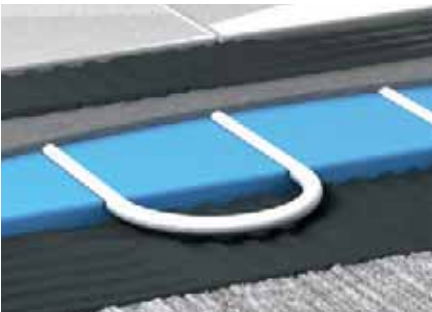

For more information on various floor fixings watch our helpful videos for step by step guidance.

Scan QR code to watch videos >





Visit us online for a list of suppliers:
www.prowarm.com



Call us direct for technical advice:
01268 567019



Unit 12, Carnival Park, Carnival Way, Basildon, Essex, SS14 3WN

T: 01268 567019

www.prowarm.com



Gas Safe registration
number: 640068